

Wechseleinsatz für u-tec System

insert for u-tec system

Größe UT 32
size UT 32

IK geeignet
suitable for IC

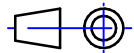

Darstellung symbolisch
symbolical drawing

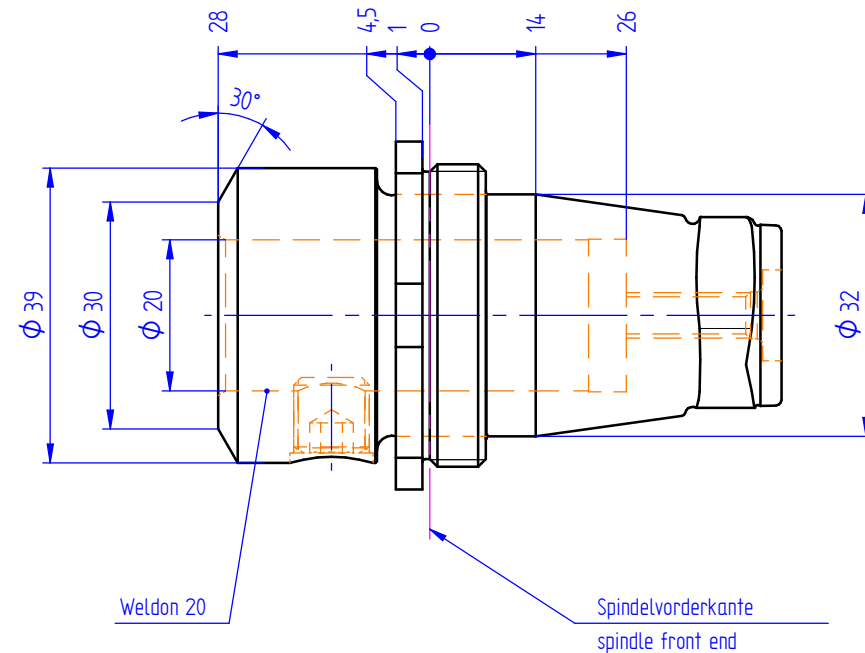
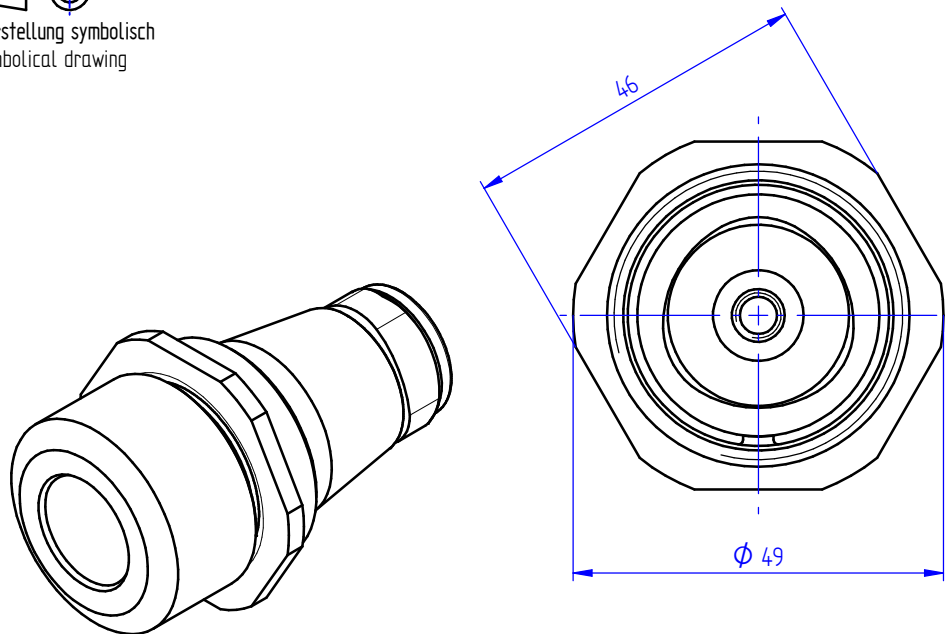

Optionen :
options :



Bedenschlüssel
wrench